

Assembly Instructions for

- FN1 (2-PIECE) CANOPY
- FN2 (3-PIECE) CANOPY

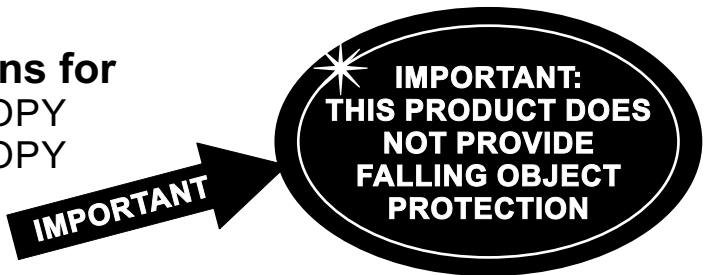

ESSENTIAL TOOLS REQUIRED:

- Phillips Head Screw Driver
- Tin Snips or Heavy Scissors
- Eye Protection
- Rubber Mallet or Hammer

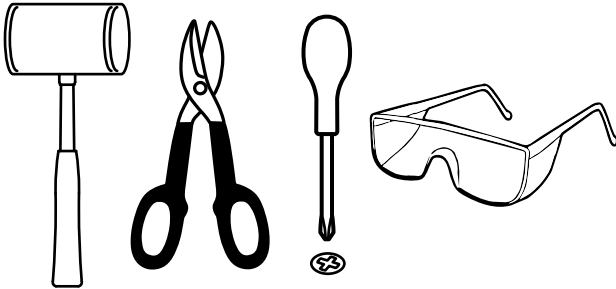

TO AVOID PRODUCT DAMAGE:

Use caution when assembling not to lay the roof on a rough surface, you may want to use the box you received it in to place the roof on.



TRANSPORTING:

When Transporting the Tractor with a CANOPY at highway speeds, make sure the Tractor is positioned to prevent wind damage to the CANOPY.



CARE AND MAINTENANCE:

Wash with soapy water or glass cleaner and dry off immediately with a dry towel. Canopy can be buffed to a high gloss using quality automotive buffing compound.

PARTS LIST

FN1 - 2-Piece Canopy:

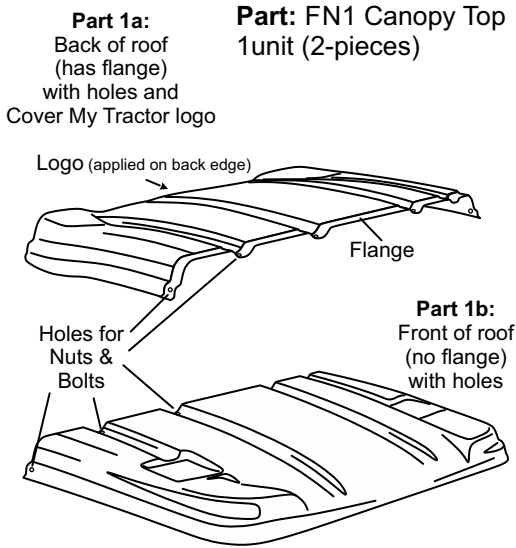

OR

FN2 - 3-Piece Canopy:

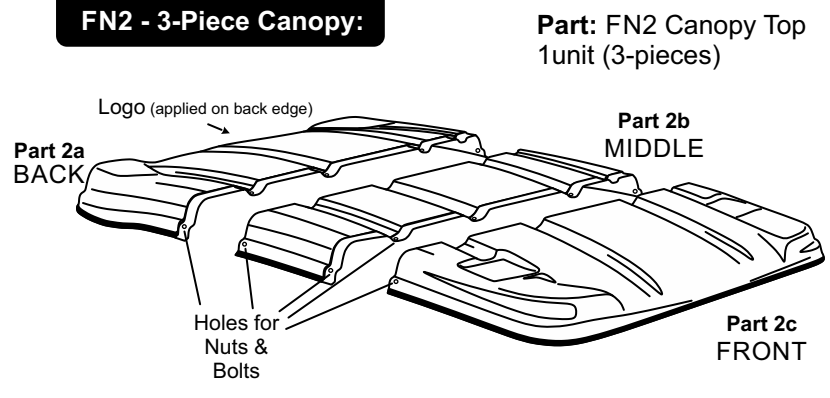

Part: FN2 Canopy Top 1 unit (3-pieces)

Overlap Seam Assembly Kit Includes:

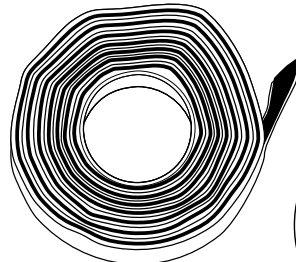

#D – Butyl Rubber Sealant Tape (12' for FN1) (24' for FN2)

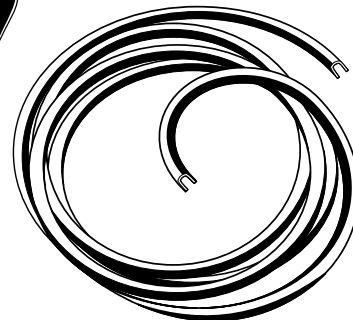

#E – Trim-Lock Edging (1)

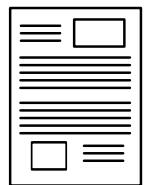

#F - Assembly Instructions (1)



#A – Bolt 1/4 - 20x3/8" (6 for FN1) (12 for FN2)



#B – Neoprene Sealing Washer (6 for FN1) (12 for FN2)



#C – Round Base Flange Nut (6 for FN1) (12 for FN2)

STEP 1a Dry Fitting and Aligning:

Dry assemble canopy joints by understanding how the pieces overlap one another. The flange and the holes align as shown in Diagrams 1 thru 1(c) for the two piece canopy, and 2 thru 2(c) for the three piece canopy.

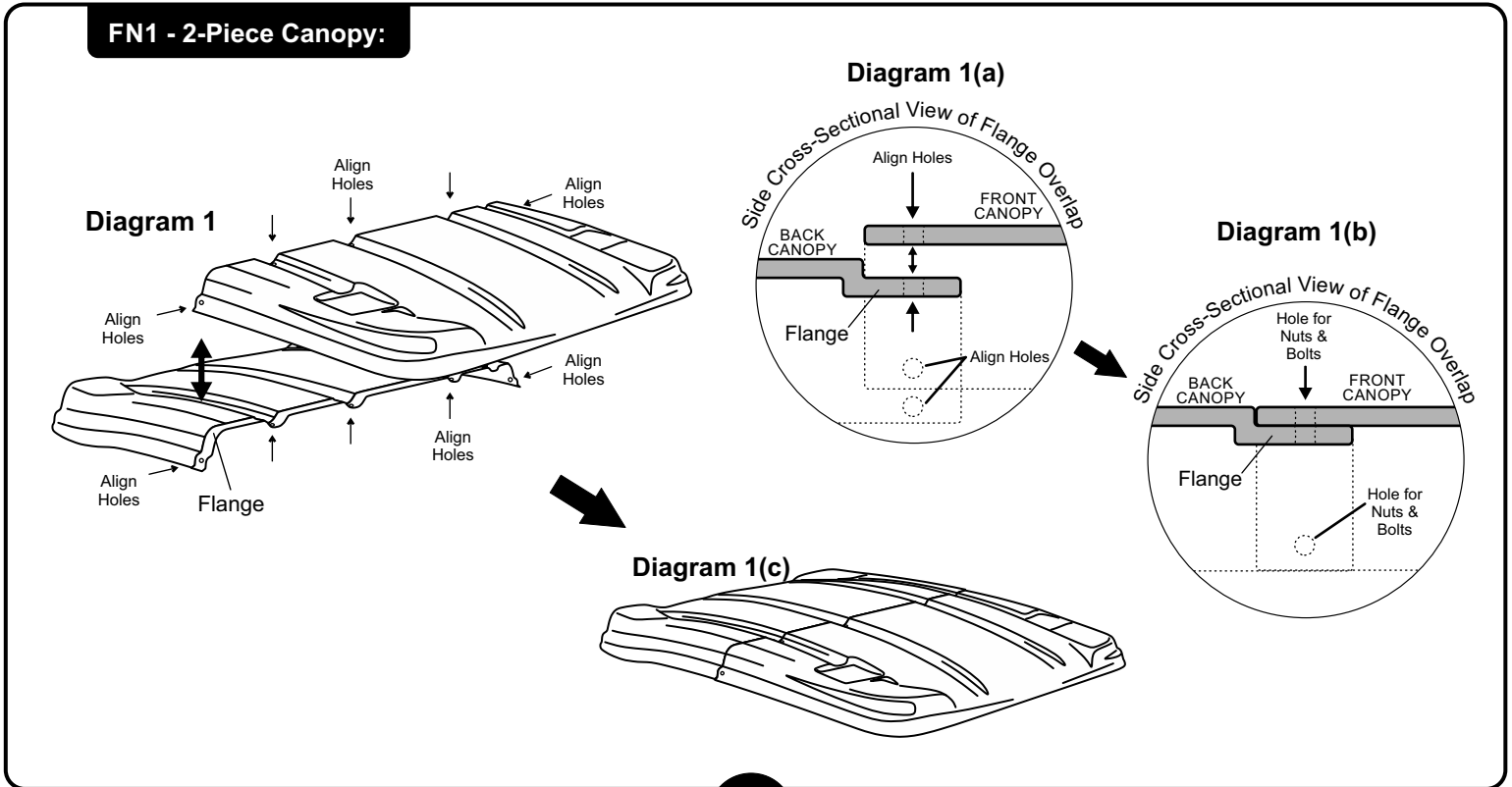

OR

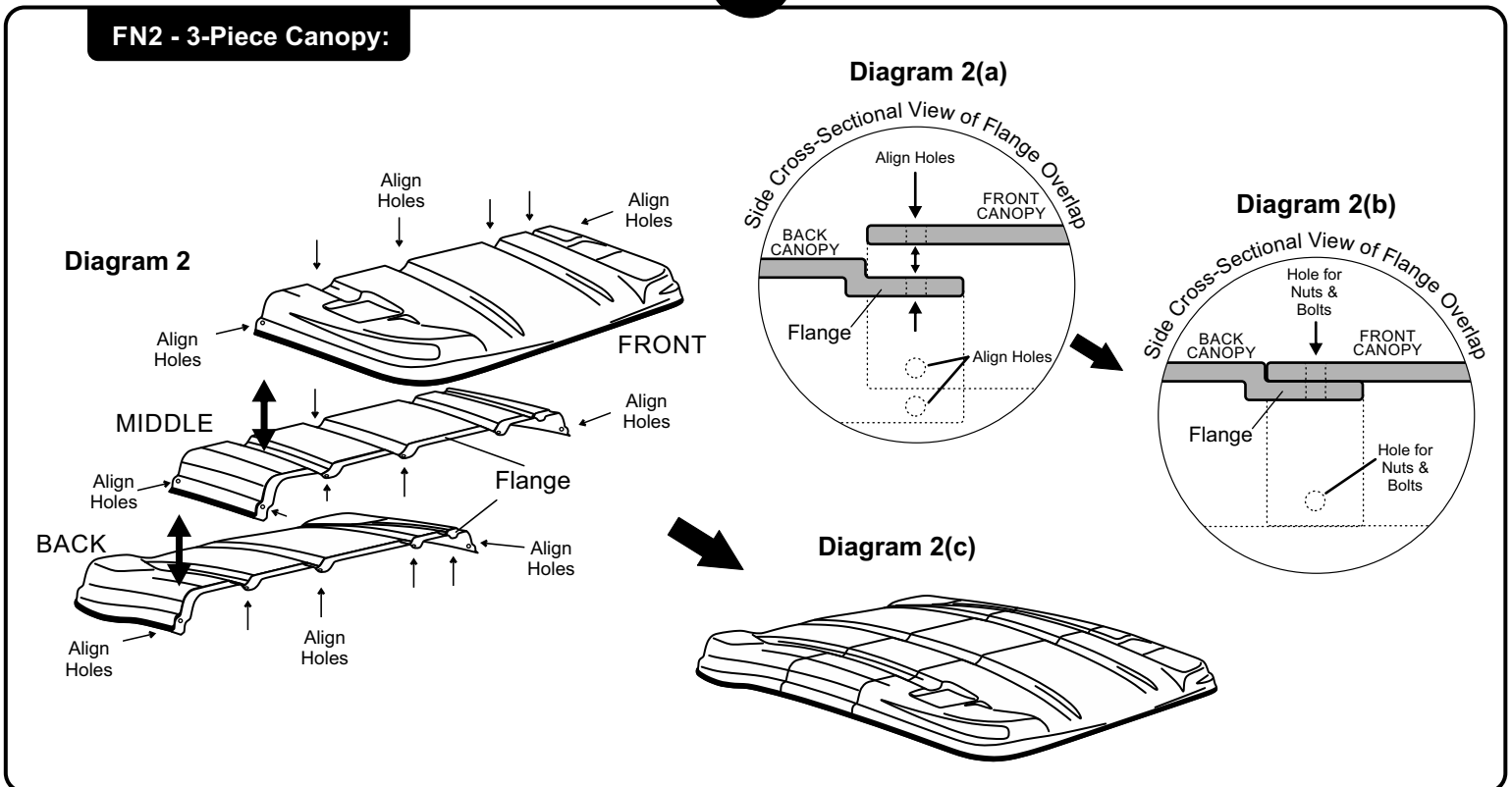

STEP 1b Finishing Alignment:

Lay on flat surface and add a support block to the center of the flanges so that no sagging between the parts occurs. When fully assembled it creates a flush surface at each part seam as shown in diagram 3 and 3(a). Remember that the adhesive tape is not applied yet and will add some dimension to each flange.

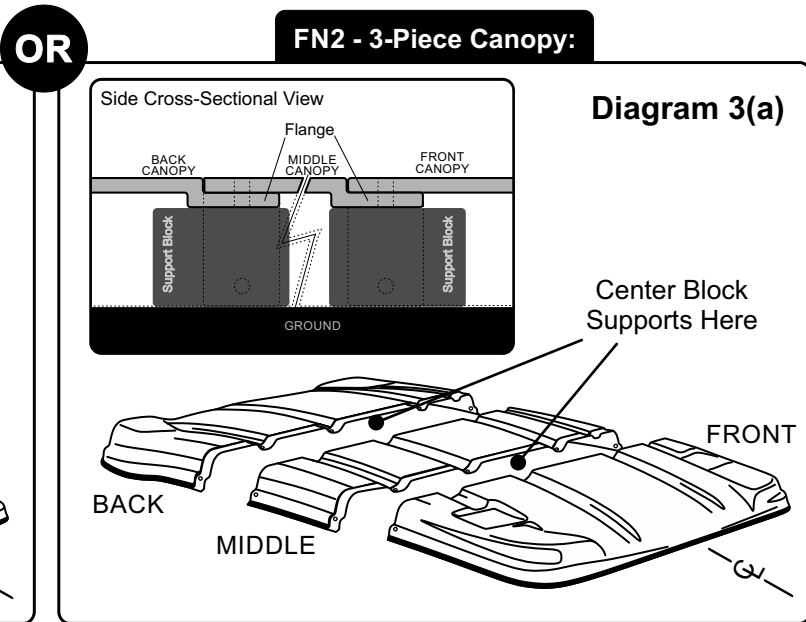
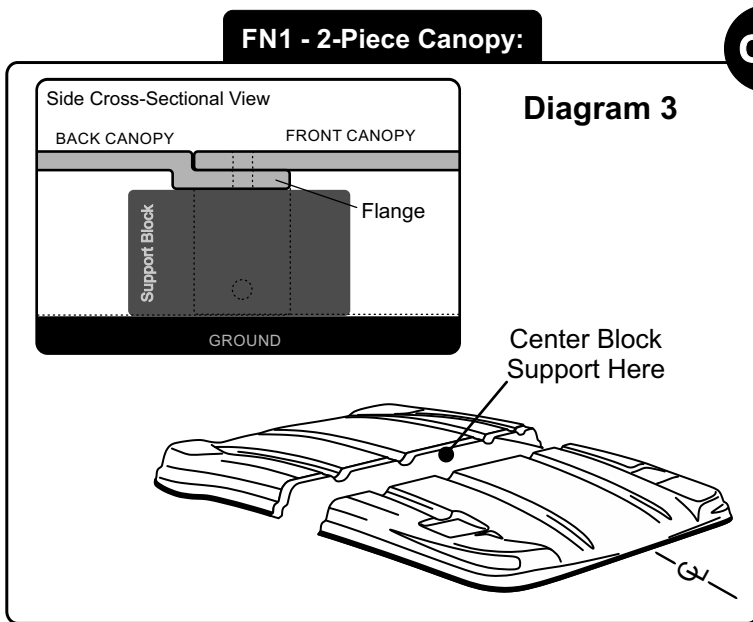

STEP 2 Applying the Sealant:

Lay the Butyl Rubber Sealant Tape "D" along the entire length of the Flange sections, near the front edge and near the back edge of the Flange sections. Start it about 1/4" to 1/2" above the side edge of the roof. Make sure not to cover the holes with the Sealant Tape (see Diagram 4).

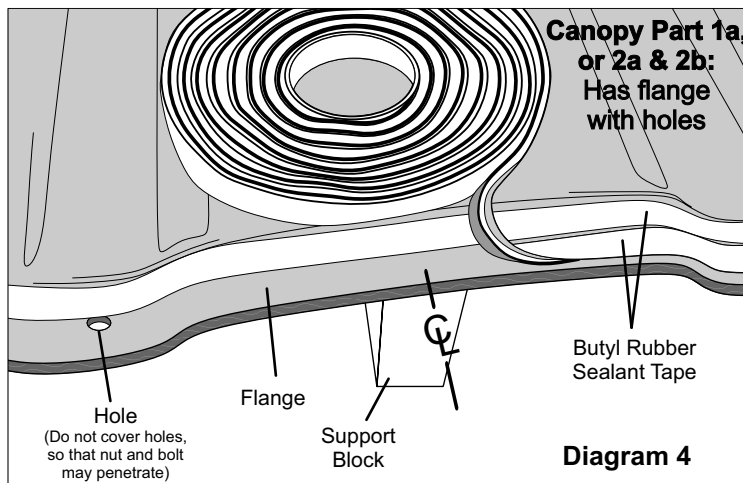

STEP 3 Join the Canopy Parts:

Peel off the film from the Butyl Rubber Sealant Tape "D" on Flanges. Align and join the parts together, lightly pushing on the seams to adhere together with the Sealant Tape. Assemble the nut and bolt fasteners per Diagram 5 and 5(a) into the bottom edge holes on each side of the seam.

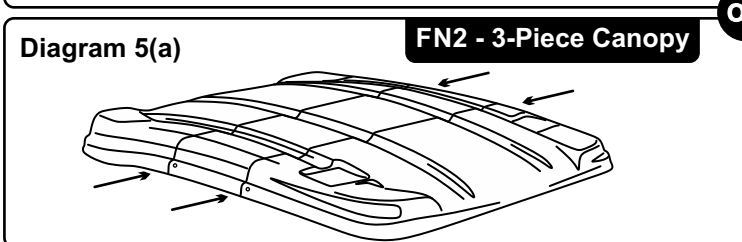
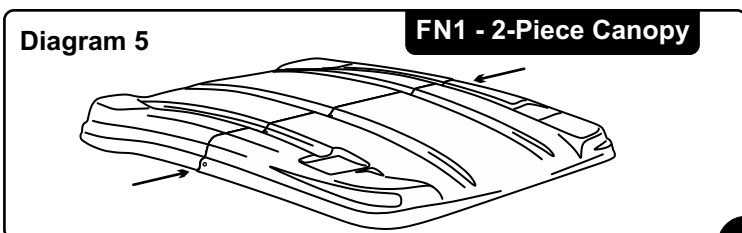

General instructions for the Bolt Assembly: Push the barrel of the Flange Nut (part #C) upward through the hole from the underside of the canopy. From the top side of the canopy insert Bolt (part #A) through the Neoprene Sealing Washer (part #B) and through the holes - screwing the Bolt into the barrel of the Flange Nut at each fastening location. Pull parts together by tightening the Bolt (part #A) into the Flange Nut (part #C).

NOTE: Hand tighten all bolts, do not over tighten as it could cause cracks in the fiberglass. Tighten each bolt sequentially, a little at a time, to distribute the pressure evenly across the joining surface - allowing for smooth pressure distribution of the Butyl Rubber Sealant Tape "D" - repeat this until the two surfaces are flush, or almost flush..

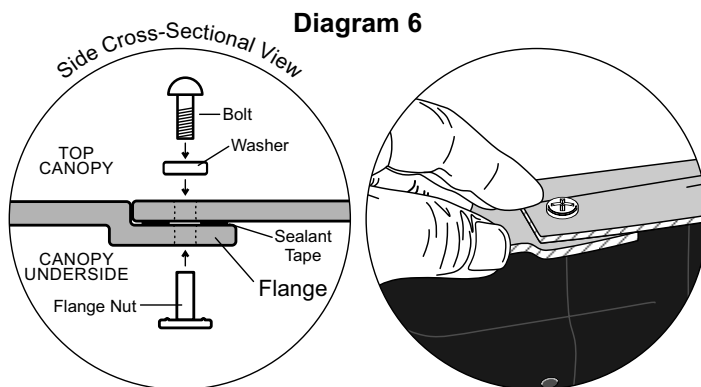

STEP 4 Fastening the Canopy:

Stand the canopy on its side against something sturdy (make sure to place against non-abrasive surface, or use a cloth, to avoid scratching the finish). (see Diagram 8). Complete the Bolt assembly procedure on the remaining fasteners, into the remaining holes — Hand tighten all bolts, do not over tighten as it could cause cracks in the fiberglass. See ‘**General instructions for the Bolt Assembly**’ section.

Clean off any excess Butyl Rubber Sealant that may have been pushed out of the seam during the bolt tightening process.

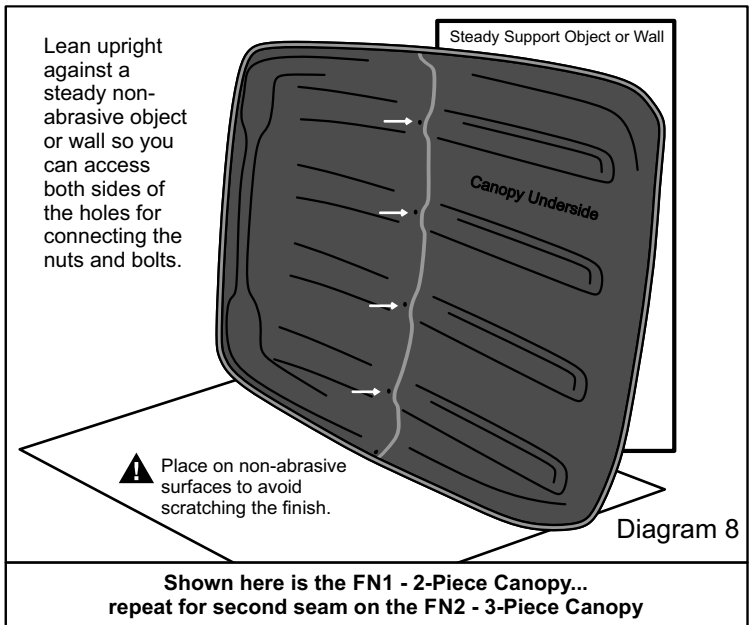
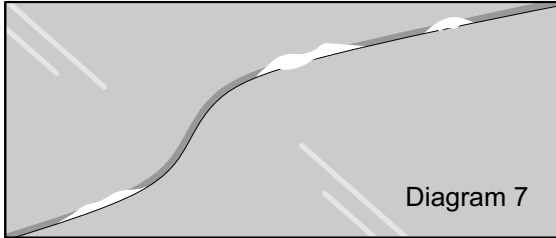

STEP 5 Applying the Trim:

Once the roof is assembled, you may put the trim (part #E) on the edge using a rubber mallet (or gently with a hammer) - lightly tapping the trim onto to the edge of the roof. Start from the center of the canopy in the back (the back has the ‘Cover My Tractor’ logo and website). (see Diagram 9)

Once you have covered the entire edge, and back to the beginning, you will cut it 1” over the end and cut with tinsnips. (see Diagram 11). **NOTE:** If it is short, the trim does have stretch and you can pull it so it will cover the edges.

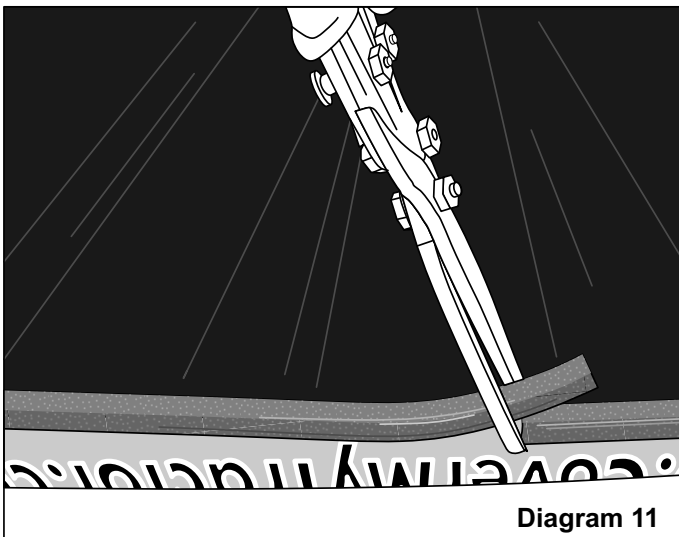
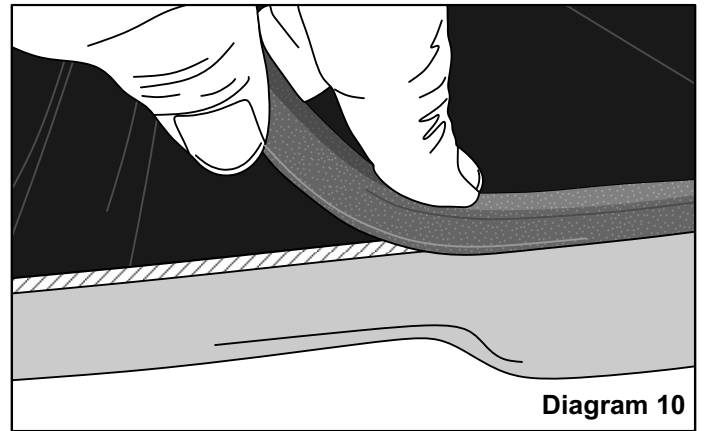
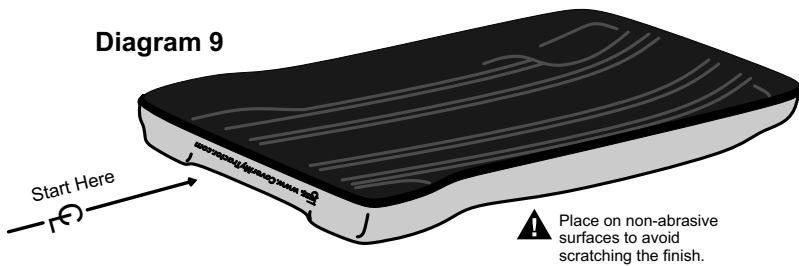

The canopy is now ready to be mounted on your tractor. PLEASE FOLLOW THE MOUNTING INSTRUCTIONS PROVIDED WITH YOUR BRACKETS.

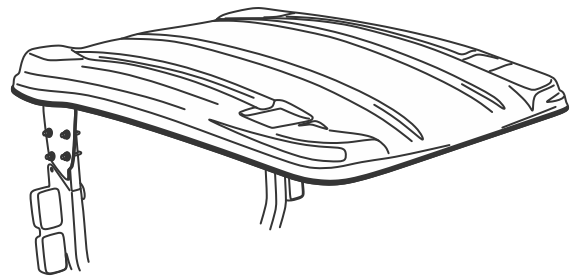

IF YOU HAVE ANY QUESTIONS PLEASE
CALL CUSTOMER SERVICE AT
(904) 316-0532 OR (904) 394-0706.

Cover My Tractor, LLC
3145 E Chandler Blvd. Ste. 110-401 Phoenix, AZ 85048
Phone: (904) 316-0532 or (904) 394-0706

For a full line of products for your tractor
visit us online at CoverMyTractor.com